



# Flex Channel

[TEXTILE WINDOW CHANNEL SEALS]



# Schlegel Flex Channel

Bridging the boundaries between materials and technology



- Retain and seal sliding with wire carriers covered with woven pile fabrics
- Resilient, compressible seals resist dust, air, and water infiltration
- Flexible for use with tight radii requirements
- Available in several widths that accept different sliding panels and frames
- constructed to meet specific design and performance criteria
- Exceeds specs for marine, Automotive, Aeronautic and RV industries
- Backed by Schlegel innovation and unmatched customer service

Schlegel's commitment to customer service is unwavering. As the industry leader, you get responsive turnaround at every step. Plus, we'll work with you to create exactly what you need, when you need it - without hassle or delay. We are ISO 9001:2000 certified.



# Window Channel Profiles

Covered with woven pile fabric, Schlegel Flex Channels retain and seal sliding panels on linear surfaces. They are flexible to accommodate tight spaces and provide for maximum ease of operation.

| PART NUMBER | A<br>BOTTOM WIDTH                             | B<br>HEIGHT    | C<br>TOP WIDTH | D<br>PILE HEIGHT | E<br>WIRE MATERIAL       |
|-------------|---|----------------|----------------|------------------|--------------------------|
| 1311-2541-9 | .420" (10.7mm)                                | .468" (11.8mm) | .480" (12.2mm) | .085" (2.2mm)    | .032" (0.8mm) Aluminum   |
| 1312-1931-8 | .420" (10.7mm)                                | .468" (11.8mm) | .480" (12.2mm) | .080" (2.0mm)    | .030" (0.7mm) Galvanized |
| 1318-1951-0 | .365" (9.3mm)                                 | .438" (11.1mm) | .410" (10.4mm) | .080" (2.0mm)    | .030" (0.7mm) Galvanized |
| 1318-2601-8 | .365" (9.3mm)                                 | .438" (11.1mm) | .410" (10.4mm) | .080" (2.0mm)    | .032" (0.8mm) Aluminum   |
| 1323-1931-9 | .420" (10.7mm)                                | .468" (11.8mm) | .480" (12.2mm) | .120" (3.0mm)    | .030" (0.7mm) Galvanized |
| 1328-2061-2 | .470" (11.9mm)                                | .375" (9.5mm)  | .500" (12.7mm) | .120" (3.0mm)    | .030" (0.7mm) Galvanized |
| 1334-2061-8 | .470" (11.9mm)                                | .375" (9.5mm)  | .500" (12.7mm) | .160" (4.1mm)    | .030" (0.7mm) Galvanized |
| 1336-2061-1 | .470" (11.9mm)                                | .375" (9.5mm)  | .500" (12.7mm) | .130" (3.3mm)    | .030" (0.7mm) Galvanized |
| 1343-2061-1 | .470" (11.9mm)                                | .375" (9.5mm)  | .500" (12.7mm) | .090" (2.3mm)    | .030" (0.7mm) Galvanized |
| 1344-2081-8 | .620" (15.7mm)                                | .480" (12.2mm) | .640" (16.2mm) | .125" (3.2mm)    | .030" (0.7mm) Galvanized |
| 1379-2601-9 | .365" (9.3mm)                                 | .438" (11.1mm) | .410" (10.4mm) | .100" (2.5mm)    | .032" (0.8mm) Aluminum   |
| 1384-2081-6 | .620" (15.7mm)                                | .480" (12.2mm) | .640" (16.2mm) | .160" (4.1mm)    | .030" (0.7mm) Galvanized |
| 1417-4041-0 | .618" (15.7mm)                                | .826" (20.9mm) | .688" (17.5mm) | .197" (5.0mm)    | .030" (0.7mm) Galvanized |
| 1454-1901-6 | .620" (15.7mm)                                | .560" (14.2mm) | .640" (16.2mm) | .125" (3.2mm)    | .030" (0.7mm) Galvanized |
| 1590-1901-3 | .620" (15.7mm)                                | .560" (14.2mm) | .640" (16.2mm) | .175" (4.4mm)    | .030" (0.7mm) Galvanized |
| 1755-2211-6 | .620" (15.7mm)                                | .350" (8.9mm)  | .312" (7.9mm)  | .070" (1.8mm)    | .030" (0.7mm) Galvanized |
| 1330-1911-6 | Special Double Channel - See Individual Print |                |                |                  |                          |

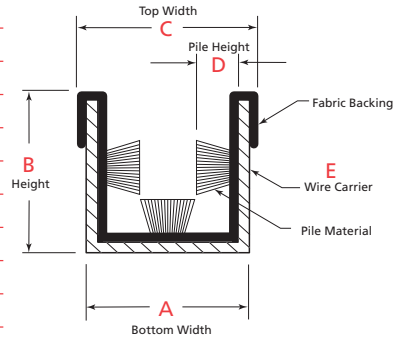

1417-4041-0

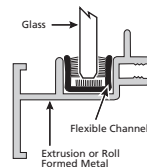
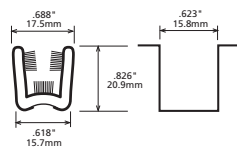

1454-1901-6

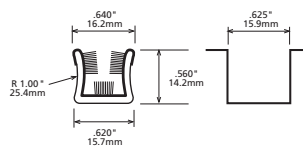

1311-2541-9 w/.032" aluminum wire  
1312-1931-8 w/.030" galvanized wire

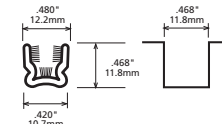

1590-1901-3

1323-1931-9

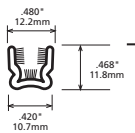

1330-1911-6

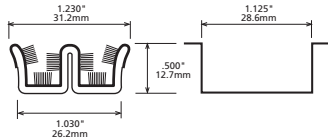

1336-2061-1

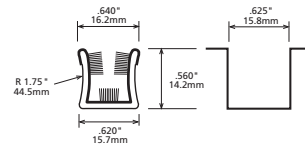
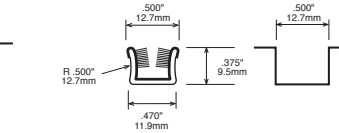

1318-1951-0 .080" pile, w/.030" galvanized wire  
1334-2061-8 .080" pile, w/.032" aluminum wire  
1379-2601-9 .100" pile, w/.032" aluminum wire

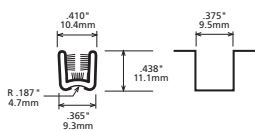

1328-2061-2 .120" pile height  
1334-2061-8 .160" pile height  
1343-2061-1 .090" pile height

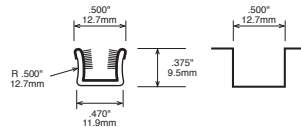

1344-2081-8 .125" pile height  
1384-2081-6 .160" pile height

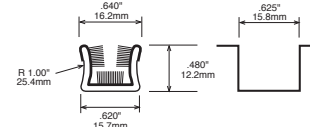

1755-2211-6

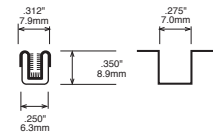

**Schlegel**®